

**NEW**  
**"ANTI-CORROSION"**



**CONCORD**

**CURB BOXES, TOOLS and ACCESSORIES**

**CLOW**  
CLOW CANADA

# CLOW CANADA

NOW AVAILABLE WITH ANTI-CORROSION  
STAINLESS UPPER SECTION AND EPOXY FINISH

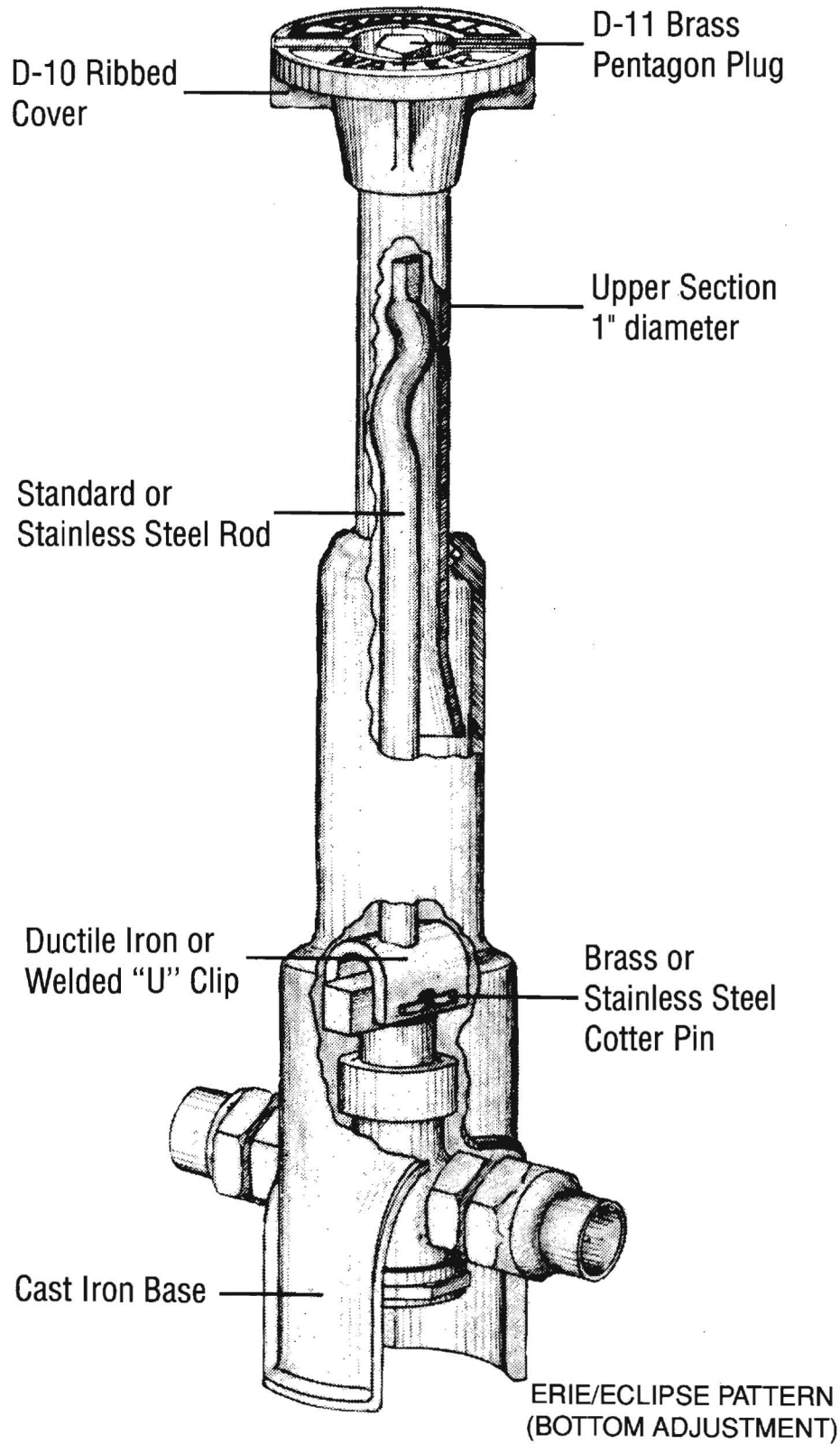

D-1 Cast iron Base  
— for 1/2", 5/8", 1" Services

D-2 Cast Iron Base  
— for 1 1/4", 1 1/2", 2" Services

## CURB BOX LIDS

D-10



D-10 Regular ribbed cover and brass pentagon plug.

D-10A Ribbed repair cover c/w set screw and brass pentagon plug.

D-10A

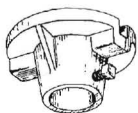

D-10D 1 1/4" ribbed cover and brass pentagon plug.

D-10DR 1 1/4" ribbed repair cover with set screw and brass pentagon plug.

D-10F

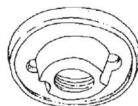

D-10F Flat cover with 1" brass thread.

NOTE: Brass hexagon plugs available on all models if specified.

## CURB BOX PARTS

D-11



D-11 Brass pentagon or hexagon plug (specify)  
 Frost ring washer  
 Brass or stainless steel cotter pin  
 Base for D-1, D-6, cast iron  
 Base for D-1P, D-6P, polyethylene  
 Base for D-2, D-7, cast iron  
 Base for D-8, cast iron.

D-17

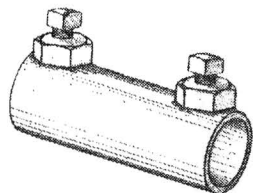

D-17 Standard repair coupling with two set screws.

D-17F Repair coupling with one female end threaded and one end with set screw.

D-18

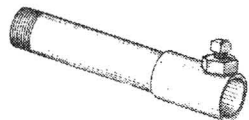

D-18 Extensions 1" male end threaded and female end with set screw.  
 Fixed length—1" pipe.  
 6, 12, 18, 24, 30, 36, 42, 48 inches.

D-18A Same as above—1 1/4" pipe fully adjustable within each length.

## SHUT OFF KEYS

D-12

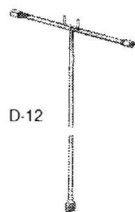

D-12 Combination Key  
 For flat lids, pentagon or hexagon plugs  
 Standard sizes: 30", 48", 60", 72"  
 Longer sizes available upon request.

D-13



D-13 Standard Key  
 Standard sizes: 30", 48", 60", 72"  
 Longer sizes available upon request.

D-19

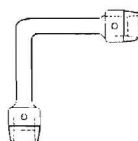

D-19 Double Key  
 5" x 5" or 10" x 10"  
 Fits pentagon and hexagon plug.

D-14

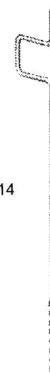

## STATIONARY RODS FOR SERVICE BOXES

T-5	9/16"	Std. Rod c/w Welded "U" Clip and Brass Cotter Pin.
T-4	1/2"	Type 304 Stainless Steel Rod c/w Welded "U" Clip. Brass or Stainless Steel Cotter Pin.
T-2	5/8"	Std. Rod c/w Ductile "U" Clip and Brass Cotter Pin.
T-8	5/8"	Std. Rod c/w Welded "U" Clip and Brass Cotter Pin.

### SIZES AVAILABLE

### WEIGHTS (LBS)

SIZE NO.	EXT IN FT. MIN-MAX	ROD LENGTH	WITH ROD		WITHOUT ROD		
			D-1	D-2	D-1	D-1P	D-2
1	1½-2½	12"	11	19	10	3	17
2	2-3	12"	12	20	11	4	18
3	2½-3½	12"	13	21	12	5	18
4	3-4	24"	14	22	13	6	19
5	3½-4½	24"	15	23	13	6	19
6	4-5	36"	16	24	14	7	19
7	4½-5½	36"	17	26	14	7	20
8	5-6	48"	18	27	15	8	21
9	5½-6½	48"	19	32	15	8	26
10	6-7	60"	20	34	16	8	27
11	6½-7½	60"	21	35	17	10	28
12	7-8	72"	22	36	18	11	29
13	7½-8½	72"	23	37	19	12	30
14	8-9	84"	24	38	20	13	31
15	8½-9½	84"	25	39	21	14	32
16	9-10	96"	26	40	22	15	33
17	9½-10½	96"	27	41	23	16	34
18	10-11	96"	28	42	24	17	35

When Ordering Specify:

- 1) Model Number
- 2) Depth of bury
- 3) Type and length of stationary rod from charts above.



**HEAD OFFICE**  
 1757 Burlington Street East  
 P.O. Box 2849  
 Hamilton, Ont. L8N 3R5  
 Tel: (905) 548-9604  
 Fax: (905) 548-6885

**WESTERN CANADA**  
 P.O. Box 1000  
 801 Smelter Ave. S.E.  
 Medicine Hat, AB T1A 7H1  
 Tel: (403) 527-3553  
 Fax: (403) 527-7454

**EASTERN CANADA**  
 P.O. Box 700  
 Saint John, NB E2L 4B3  
 Tel: (506) 633-2541  
 Fax: (506) 634-8936