

SECTION A-A
SCALE 1 : 3

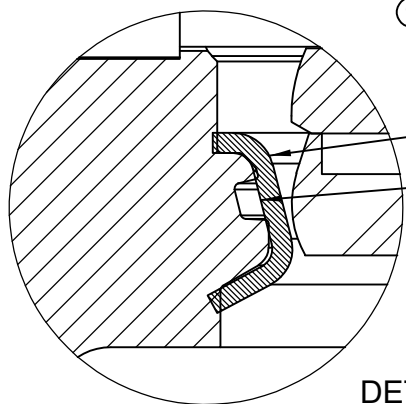

DETAIL B
SCALE 2 : 1

ITEM NO.	DESCRIPTION	MATERIAL
1	VANE SHAFT	304 STAINLESS STEEL, ASTM A-276
2	V-RING PACKING SET	EPDM, BUNA-N
3	BFV BODY	DUCTILE IRON ASTM A-536
4	UPPER JOURNAL BEARING	NYLATRON
5	VANE SEAT RING	EPT with SS INSERT
6	HEX HEAD CAPSCREW	18-8 STAINLESS STEEL with NYLOC PATCH
7	LOWER JOURNAL BEARING	NYLATRON
8	BFV BODY END PLUG	STEEL
9	BFV VANE	DUCTILE IRON ASTM A-536
10	VANE SHAFT TORQUE PLUG	18-8 STAINLESS STEEL
11	BODY SEAT RING	316 STAINLESS STEEL
12	BODY SEAT O-RING	BUNA-N

PROJECT
OWNER
CONTRACTOR
DISTRIBUTOR
CONSULTANT

CLOW CANADA

8" AWWA C504 - Style 4500 - CL150
BFV with F/A 12 MSS/ISO Connection
Sub-Assembly - Material List
MJ ENDS

DWG. NO.
8in ISO-G